



**GENERAL INSTALLATION, OPERATION,
MAINTENANCE AND TROUBLESHOOTING MANUAL
FOR
THREE SCREW AND CIG SERIES PUMPS**



WARNING

This manual, and the pump specific Product Service Manual, should be read thoroughly prior to pump installation, operation, maintenance or troubleshooting.

CAUTION

ATTENTION

Page 2 of this manual has been added to emphasize the requirements of filling and venting the seal chamber prior to starting pump to prevent seal leakage and failures.

Manual No. SRM00046

Rev. 10 (20-0051)

February 2020

Note: This page was added because of the prevalence of seal damage and leakage caused by not venting the seal chamber before putting a pump in service.

Seal Chamber Priming for pumps with seal vents:

Fill mechanical seal chamber with liquid to insure seal does not start dry. This can be done by removing seal vent set-screw and pouring fluid into seal vent before opening pump inlet. Alternately, seal chamber can be vented in situations where inlet pressure is above atmospheric by opening inlet and discharge valves and then loosening seal vent plug to allow positive inlet pressure to push air out of seal chamber until oil flows from it. **See figure below.**

Seal chamber priming for 3E model pumps with mechanical seals:

For the Imo 3E Model pumps with mechanical seals, there is no seal vent port. The mechanical seal in these model pumps is located in the discharge chamber of the pump and is in the fluid flow path. In these model pumps the complete pump must be filled and vented of any trapped air prior to starting the pump. Contact the factory if you have questions. **See Figure 8 on page 12 and Figure 12 on page 18 of this manual for suction piping and pump filling methods.**

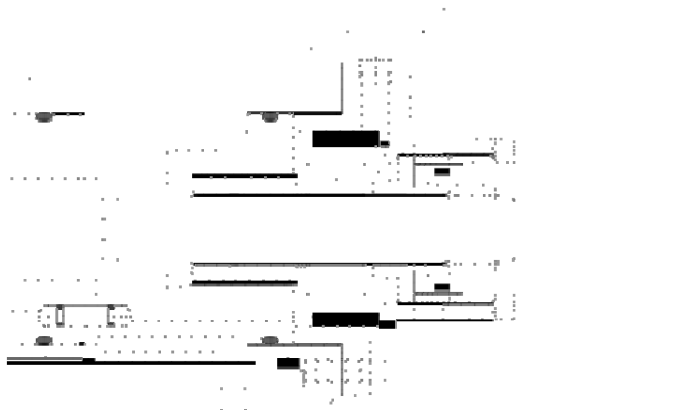

Filling or Venting Seal Cavity Using Seal Vent

CAUTION

- Failure to fill or vent seal chamber as described above may cause damage to seal running faces which may result in seal leakage.



READ THIS ENTIRE PAGE BEFORE PROCEEDING

FOR SAFETY OF PERSONNEL AND TO PREVENT DAMAGE TO EQUIPMENT, FOLLOWING NOMENCLATURE HAS BEEN USED IN THIS MANUAL:

	DANGER	Failure to observe precautions noted in this box can result in severe bodily injury or loss of life.
---	---------------	--

	WARNING	Failure to observe precautions noted in this box can cause injury to personnel by accidental contact with equipment or liquids. Protection should be provided by the user to prevent accidental contact.
---	----------------	--

CAUTION		ATTENTION
Failure to observe the precautions noted in this box can cause damage or failure of the equipment.		

Non compliance of safety instructions identified by following symbol could affect safety for persons:	Safety instructions where electrical safety is involved are identified by:	Safety instructions which shall be considered for reasons of safe operation of pump and/or protection of pump itself are marked by sign:
		ATTENTION

	ATTENTION	
If operation of this pump is critical to your business, we strongly recommend you keep a spare pump or major repair kit in stock at all times. As a minimum, a minor repair kit (o-rings, gaskets, shaft seal and bearings) should be kept in stock so pump refurbishment after internal inspection can be accomplished.		

CONTENTS

SAFETY AND TABLE OF CONTENTS.....	3
A - GENERAL	4
B - TRANSPORTATION AND STORAGE.....	4
C - DESCRIPTION OF THE PUMP.....	4
D - INSTALLATION/ASSEMBLY.....	4
E - STARTUP, OPERATION AND SHUTDOWN.....	16
F - MAINTENANCE.....	20
G - FIELD AND FACTORY SERVICE.....	22
H - TROUBLESHOOTING	23
I – UPACKAGING, INSPECTION & RE-PRESERVATION FOR PUMPS & MOTOR UNITS....	24 - 25
J - UPACKAGING, INSPECTION & RE-PRESERVATION FOR PUMPS, PARTS & KITS.....	26

APPLICATIONS MANUAL FOR IMO PUMPS

A. GENERAL

Instructions found herein cover general installation, operation, maintenance and troubleshooting of subject equipment. NOTE: Individual contracts may have specific provisions that vary from this manual. Should any questions arise which may not be answered by these instructions, refer to specific pump instruction manual provided with your order. For further detailed information and technical assistance to questions not answered by these manuals, please refer to Imo Pump, Technical/Customer Service Department, at (704) 289-6511.

This manual cannot possibly cover every situation connected with installation, operation, maintenance and troubleshooting of equipment supplied. Every effort was made to prepare text of manual so that engineering and design data was transformed into easily understood wording. Imo Pump must assume personnel assigned to operate and maintain supplied equipment and apply instruction manual have sufficient technical knowledge and experience to use sound safety and operational practices which may not be otherwise covered by this manual.

In applications where equipment furnished by Imo Pump is to become part of a process or other machinery, these instructions should be thoroughly reviewed to determine proper fit of equipment into overall plant operational procedures.



WARNING

If installation, operation, and maintenance instructions are not correctly and strictly followed and observed, injury to personnel or serious damage to pump could result. Imo Pump cannot accept responsibility for unsatisfactory performance or damage resulting from failure to comply with instructions.

B. TRANSPORTATION AND STORAGE

Always protect the pump against taking in water and other contaminants. Store the pump in a clean, dry and relatively warm environment. Pumps are delivered with their internals oiled (unless specified otherwise by the customer order) and with protective covers in or over all openings. These covers should remain in place during the mounting and alignment procedures. The covers must be removed just prior to attaching system piping to pump. If pumps are to be stored in other than a clean, warm, or dry environment, or if they are to be stored for more than six months, contact Imo for appropriate storage procedures.

C. DESCRIPTION OF THE PUMP

See specific pump instruction manual provided with your order.

D. INSTALLATION / ASSEMBLY



WARNING



On critical or dangerous equipment, provide safety and emergency systems to protect personnel and property from injury due to pump malfunction. If pumped liquids are flammable, toxic, corrosive, explosive or otherwise hazardous, provide for safety in the event of leakage or malfunction. BEFORE working on equipment, make sure all power to equipment is disconnected and locked-out.

D.1 TOOLS

Procedures described in this manual require common mechanics hand tools, dial indicators for alignment and suitable lifting devices such as slings, straps, spreader bars, etc.

D.2 LIFTING OF PUMP AND PUMP/DRIVER ASSEMBLIES

All pumps and pump/driver assemblies should be lifted with appropriate devices securely attached to whole unit. Ensure unit's center-of-gravity is located between lifting points. See Figure 1. This will avoid tipping of pump or pump/driver assembly. Spreader bars should be used as necessary to insure load is properly distributed and lifting straps do not damage equipment.

Some pumps and pump/driver assemblies have designated lifting points that are shown on their outline drawings.

	DANGER	ATTENTION
<p>Lifting a vertical pump/driver using straps or hooks attached to the pump or pump-to-driver bracket may be dangerous since the center-of-gravity of the assembly may be higher than the points of attachment. Take precautions to prevent slippage of slings and hooks. Always use properly rated lifting devices.</p>		

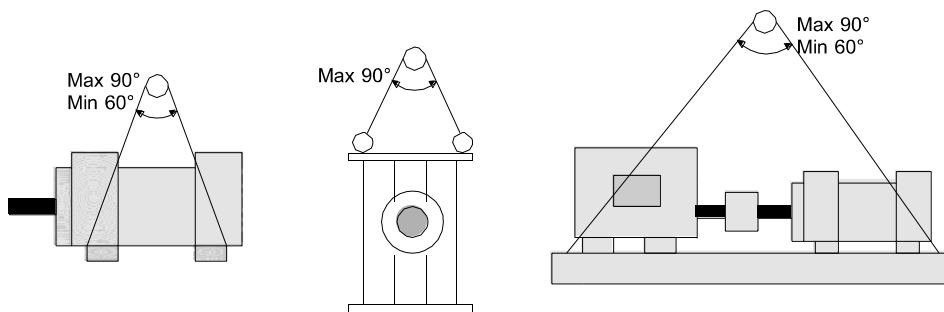

Figure 1 – Lifting Pumps and Pump/Driver Assemblies

D.3 INSTALLATION OF PUMP ASSEMBLY

To insure adequate flow of liquid to pump's inlet port, place pump near liquid source and preferably place pump centerline below liquid surface. Use short, straight inlet lines.

A dry, clean, well-lit and well-ventilated site should be selected for installing the pump assembly.

Sufficient open space should be provided around pump rotor and/or gear housing to permit routine visual inspection, on-site service and maintenance, and pump replacement. For installation and servicing of large pump units, ample overhead clearance should be provided to allow for lifting device maneuvering.

D.4 FOUNDATIONS AND BASEPLATES

Foundations and baseplates must be designed and installed so pump and driver alignment can be maintained at all times. Be sure baseplates are level and rest on smooth flat surfaces. Small pumps may be mounted on baseplates or directly to existing floors that meet the criteria of foundations. Larger pumps and/or drivers must be mounted to baseplates and foundations. It is recommended that pumps and their drivers be mounted on common baseplates.

D.5 MOUNTING OF FOOT MOUNTED PUMPS AND DRIVERS

Some pumps are shipped on baseplates without drivers. For these units, install and tighten each coupling half on driver and pump shafts. Place driver on baseplate and set proper distance between shafts and coupling hubs (See Figure 2). Locate driver so pump and driver shafts are in axial alignment. See Section D.6 on Alignment.

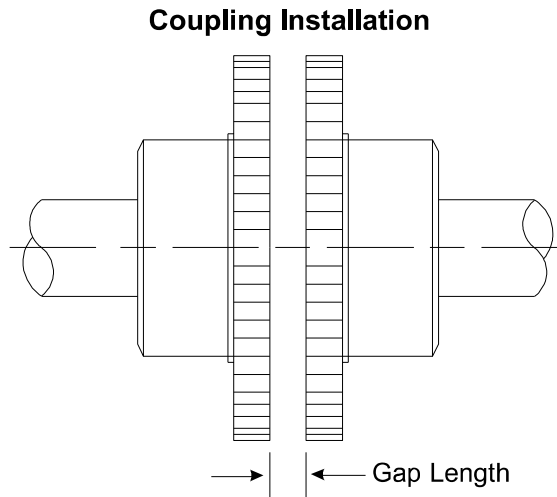

Figure 2 – Coupling Gap Measurement

For pumps driven through a separate gearbox or other device, first align device relative to pump, and then align driver relative to device.

See Section D.6.5 for belt-driven pumps. On horizontal pump/driver assemblies, shaft couplings are often shipped disassembled to prevent coupling damage during shipping and handling.

When not supplied by the manufacturer, coupling, shaft and/or belt guards conforming to ANSI B15.1 should be installed for personnel protection during pump operation.

Final alignment of pump and driver should take place after unit is secured to foundation. If baseplate is to be grouted, this should be completed before final alignment.

NOTE: Grouting is recommended to prevent lateral shifting of baseplate, not to take up irregularities in the foundation. For installations requiring grouting, a baseplate designed specifically for this purpose is needed.

	WARNING
Install guards over couplings and shafts to protect personnel from accidental contact with rotating couplings, belts, sheaves, chains, shafts and/or keyways.	

D.6 ALIGNMENT

D.6.1 General

All pump and driver assemblies must be aligned after site installation and at regular maintenance intervals. This applies to factory-mounted units (new or rebuilt) because factory alignment is often disturbed during shipping and handling. Flexible couplings shall be used to connect pump to its driver (unless otherwise specified by Imo Pump).

The objective of any aligning procedure is to align shafts (not align coupling hubs) by using methods that cancel out any surface irregularities, shaft-end float, and eccentricity. At operating temperatures above 175° F (65° C), pumps require “hot alignment” after pump and driver reach normal operating temperatures. Also, re-check final alignment after all piping is connected to pump.

D.6.2 Flexible Shaft Couplings

Flexible couplings are intended to provide a mechanically flexible connection for two aligned shaft-ends. Flexible couplings are not intended to compensate for major angular or parallel shaft misalignment. The allowable misalignment varies with the type of coupling. Any improvement in alignment beyond coupling manufacturer’s minimum specification will extend pump, mechanical seal or packing, coupling, and driver service life by reducing bearing loads and wear.

CAUTION	ATTENTION
<ul style="list-style-type: none"> • Flexible couplings are NOT intended to permit significant shaft misalignment. Proper alignment must be established/maintained to obtain proper operation and maximum life. • Pump alignment requirements are nearly always more strict than coupling alignment requirements. Regardless of coupling manufacturer’s stated limits, pump-to-driver shaft alignment <u>must</u> be per pump’s alignment requirement. • Be sure all coupling set-screws and bolts are tight and coupling gap is properly set. 	

D.6.3 Aligning Foot Mounted Pumps - See Figure 3

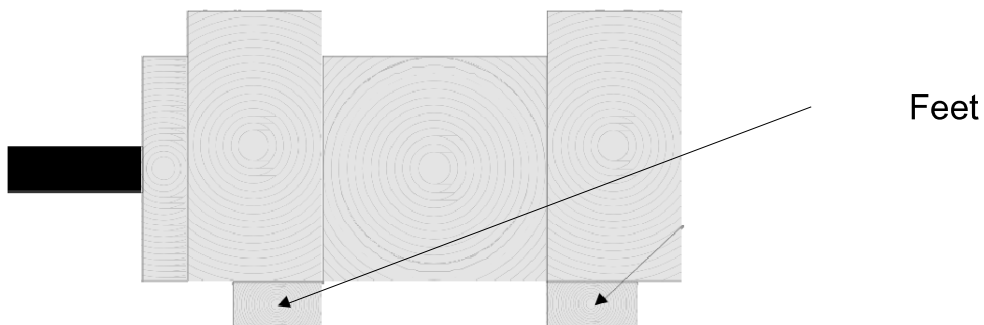
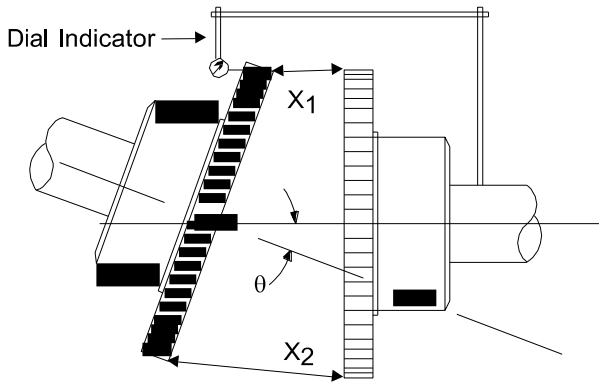

Figure 3 – Foot Mounted Pump

To install foot mounted pumps, perform the following:

- Install pump and driver onto baseplate after installing appropriate coupling halves on pump and driver shafts.
- Perform alignment of pump and driver shafts using dial indicators. Acceptable alignment has been attained when FIM (Full Indicator Movement) is less than or equal to 0.005 inch (0.13 mm) for face (angularity) and rim (parallelism) readings at or near coupling outer diameter while rotating both shafts together one full turn (360°). See Figure 4.



A. Face Check (Angularity)

Rotating both shafts together for one full turn, align pump and driver until shaft centerlines are parallel ($\theta = 0, X_1 = X_2$) within 0.005 inch (0.13 mm) FIM.

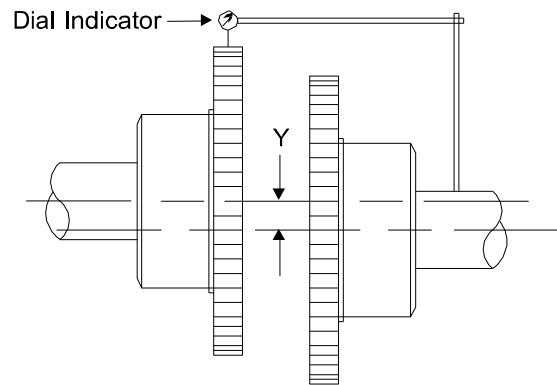

B. Face Check (Parallelism)

Rotating both shafts together for one full turn, align pump and driver until shaft centerlines coincide ($Y = 0$) within 0.005 inch (0.13 mm) FIM.

Figure 4 – Coupling and Hub Alignment

D.6.4 Aligning Flange Mounted Pumps and Drivers - See Figure 5

Mounting Flange

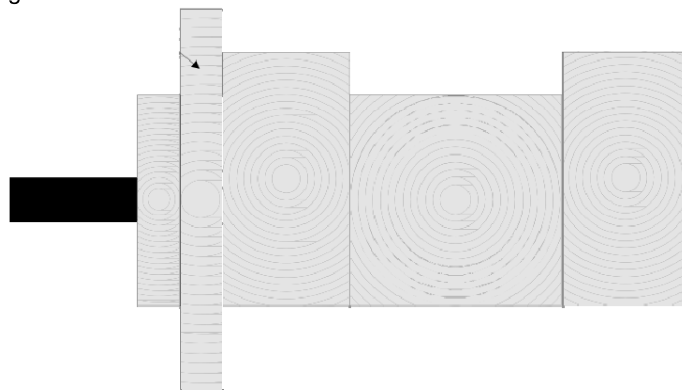

Figure 5 – Flange Mounted Pump

Shaft alignment requirements for flange mounted pumps are the same as for foot mounted pumps. That is, shafts must be aligned within 0.005 inch (0.13 mm) FIM (Full Indicator Movement) for face (angularity) and rim (parallelism) at or near coupling outer diameter while rotating both shafts together one full turn (360°).

When a pump and driver are both flange mounted to a bracket, **DO NOT** assume bracket will automatically align shafts to the above requirements. Brackets must be designed to obtain/maintain required alignment as well as to support pump weight plus any (small) residual piping forces without distorting. If at all possible, bracket design should include adequate room to check shaft alignment with dial indicators with both pump and motor mounted onto bracket. See Figure 4. If this is not possible, align bracket to driver shaft (see Figure 6), then attach pump to bracket (assumes pump fits snugly into its mounting bore in the bracket).

After pump-bracket-driver is installed into system and after piping is connected to pump, shaft alignment should be re-checked and adjusted, if necessary,

When a right-angle foot bracket is used, mount pump onto bracket and tighten pump-to-bracket mounting bolts. At this point, bracket base, in effect, becomes pump feet. Continue with aligning procedure as if pump were foot mounted. See Section D.6.3.

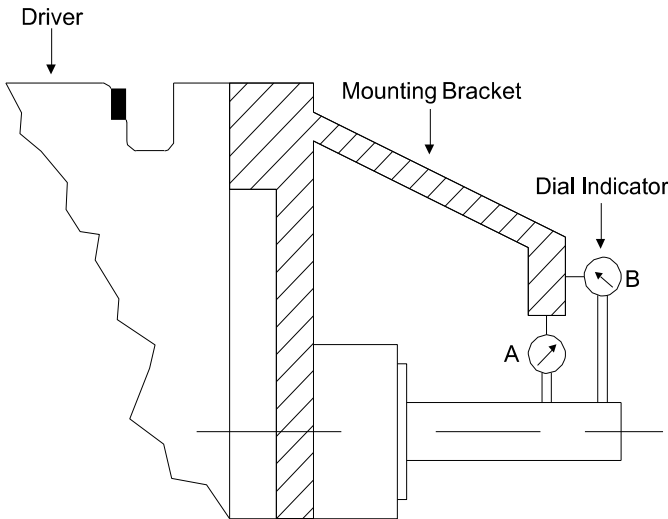

Flange Mounted Pumps

Locating bore (A) must be concentric to driver shaft centerline within 0.002 inch FIM. Mounting surface (B) must be perpendicular to driver shaft centerline within 0.002 inch (0.05 mm) FIM.

Figure 6 – Alignment of Flange Mounted Pumps

CAUTION	ATTENTION
<ul style="list-style-type: none"> • Be sure all coupling set screws and bolts are tight and coupling gap is properly set. • Install safety shield(s) or plate(s) over bracket opening(s). 	

D.6.5 Belts and Sheaves

It is only acceptable to belt drive Imo pumps that are specifically designed for this purpose. It is generally not acceptable to belt drive pumps with ratings in excess of 600 psi differential pressure. **Contact Imo if not sure a particular pump can be belt driven.**

Belts and sheaves must be properly selected aligned and tensioned to minimize belt wear, eliminate possibility of belt turnover in sheave grooves, and avoid excessive side load on pump shaft. Adjustable slide rails mounted under driver are recommended for proper belt tensioning.

Check belt tension frequently during first 24 to 48 hours of run-in operation. Follow belt drive manufacturer's recommendations for alignment of sheaves and belt-tension settings.

CAUTION	ATTENTION
<p>Loose, slipping belts will squeal and cause overheating of sheaves leading to reduced belt life. Excessively tightened belts will result in reduced belt and bearing life and possible bearing or shaft failure.</p>	

D.7 PIPING AND VALVES

D7.1 General

Piping connected to pump **MUST** be independently supported and not allowed to impose strains on pump casing including allowing for expansion and contraction due to pressure and temperature changes.

To prevent foaming and air entrainment, all return lines in recirculating systems should end well below liquid surface in reservoir. Bypass liquid from relief pressure and flow control valves should be returned to source (tank, reservoir, etc.), **NOT** pump inlet line.

Shut-off valves should be installed in both suction and discharge lines so pump can be hydraulically isolated for service or removal. All new piping should be flushed clean before connecting to pump.

CAUTION

ATTENTION

- Pipe strain will distort a pump. This could lead to pump and piping malfunction or failure.
- Return lines piped back to pump can cause excessive temperature rise at pump which could result in catastrophic pump failure.

D.7.2 Variable Frequency Drives (VFD)

When utilizing VFD's with positive displacement pumps, consideration must be given to the minimum and maximum speed range intended for the pumping application. Maximum speed must consider the inlet pressure available for the fluid viscosity range. The minimum operating speed is dependent on the minimum operating viscosity and associated discharge pressure.

When starting positive displacement pumps with VFD's, there will be a delay from the initial start until the motor reaches the selected minimum operating speed. In some applications, such as crude oil pipeline transfer, the pump needs to be operated in full fluid bypass mode through a control valve loop during the VFD speed ramp-up time. Once the minimum operating speed is attained, the control valve should completely close and the system operated as intended. The time delay should be relatively short, approximately 30 seconds to two minutes. For system shut down, it is recommended this procedure be followed in reverse order. If a pump is to be driven by a VFD, this detail should be addressed during the pump selection process. **Contact Imo Pump if there are any questions concerning VFD operation with positive displacement pumps.**

D.7.3 Relief Valve

Use relief valves to protect pumps from overpressure. They need to be connected to pump discharge lines as close to pumps as possible and with no other valving between pumps and relief valves. Relief valve settings should be set as low as practical.

DO NOT set relief valve higher than maximum pressure rating of pump, including pressure accumulation at 100% bypass. Relief valve return lines should NOT be piped into pump inlet lines because they can produce a loop that will overheat pump. See Figure 7.



DANGER

The lmo pump is a positive displacement type. It will deliver (or attempt to deliver) flow regardless of back-pressure on unit. Failure to provide pump overpressure protection can cause pump or driver malfunction and/or rupture of pump and/or piping.

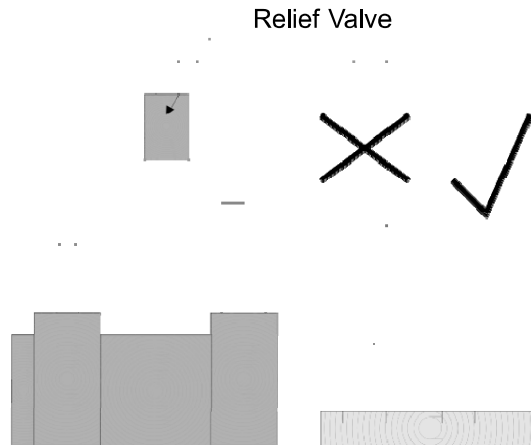

Figure 7– Proper Relief Valve Return Line Arrangement

Some low pressure pump models include built-in safety relief valves. They are intended only for emergency operation, NOT for system control. Extended operation of relief valves in these pumps could lead to pump damage or failure.

D.7.4 Suction Line

Suction line should be designed so pump inlet pressure, measured at pump inlet flange, is greater than or equal to minimum required pump inlet pressure (also referred to as Net Positive Inlet Pressure Required or NPIPR). Suction line length should be as short as possible and equal to or larger than pump's inlet size. All joints in suction line must be tight and sealed. If pump cannot be located below liquid level in reservoir, position suction line or install a foot valve so liquid cannot drain from pump while it is shut down. See Figure 8. When pump is mounted vertically with drive shaft upward, or mounted horizontally with inlet port opening other than facing upward, a foot valve or liquid trap should be installed in suction line to prevent draining. Suction line should be filled before pump start-up.

CAUTION	ATTENTION
DO NOT operate pump without liquid or under severe cavitation.	

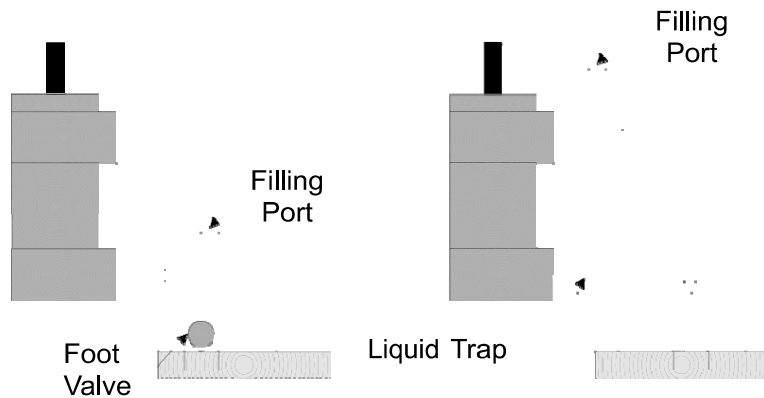

Figure 8 – Fluid Trap and Foot Valve Arrangements for Vertical Pumps

D.7.5 Suction Strainer /Filter

Pump life is related to liquid cleanliness. Suction strainers or filters should be installed in all systems to prevent entry of large contaminants into pump. See Figure 9.

Purpose of a suction strainer or filter is for basic protection of internal pumping elements. It should be installed immediately ahead of inlet port. This location should provide for easy cleaning or replacement of strainer element. Appropriate gages or instrumentation should be provided to monitor pump pressure. Pressure drop across a dirty strainer must not allow inlet pressure to fall below NPIPR. General guidelines for strainer sizing are as follows:

When pumping relatively clean viscous liquids (over 5000 SSU), use 10 to 12 mesh screens or those with about 1/16 inch (about 1 ½ mm) openings.

When pumping relatively clean light liquids such as distillate fuels, hydraulic oil and light lube oils, use suction strainers of 100 to 200 mesh.

When pumping heavy crude oils, use 5 to 6 mesh strainer screens or those with about 1/8 inch (3 mm) openings.

When pumping relatively clean distillate fuels in high pressure fuel supply systems, use 25 micron “absolute” filters for three screw pumps and 10 micron “absolute” filters for gear pumps.

Make sure size/capacity of strainer or filter is adequate to prevent having to clean or replace elements too frequently.

CAUTION	ATTENTION
<p>Before connecting pump to system, all system piping must be thoroughly flushed to remove debris which accumulates during fabrication, storage, and installation. No pumps should not be used for flushing. One large, hard particle may cause internal damage, possibly requiring a pump overhaul. Pay particular attention to suction line between suction strainer and pump to be sure it is clean.</p>	

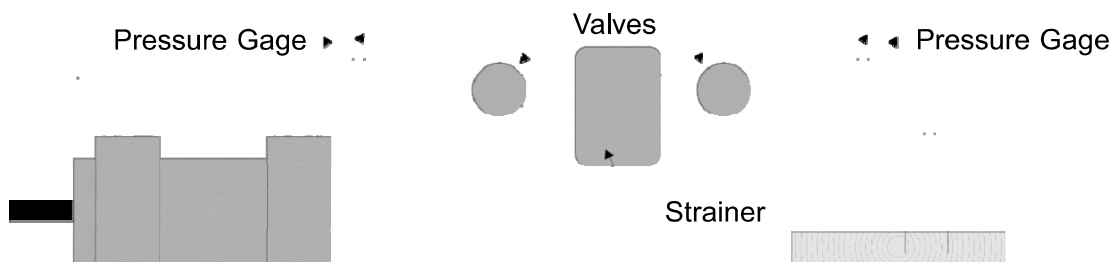

Figure 9 - Ideal Strainer Arrangement

D.7.6 System Filtration

In systems that recirculate pumped liquid, downstream (pressure and/or return side) filtration should be installed. Downstream filters may also be required to protect components such as servo valves in hydraulic systems or high-pressure fuel nozzles and flow dividers in fuel oil supply systems for gas turbines. System's most contamination-sensitive component determines its liquid cleanliness requirement. For optimum lmo pump life when running on fuel oil, light lube oil, hydraulic oil and other relatively low viscosity (thin) liquids, a high efficiency 10 micron "absolute" or finer filter is recommended. This same filter rating is recommended for pumps running at extreme operating conditions and/or in harsh environments. For pumps running on relatively clean, more viscous (thicker) liquids, filter ratings as high as 25 micron "nominal" may be acceptable as long as operating conditions and the operating environment are moderate. **lmo should be contacted for filtration requirements for pumps running on very low viscosity (water thin) and low lubricity as well as for those with an unusually large quantity of contaminants.**

System builder determines filter size (dirt holding capacity) by amount and size of contamination expected to be produced by system and other external contamination sources, by allowable pressure drop across filter and by acceptable frequency for cleaning/replacing filter elements.

D.7.7 Outlet Piping

In general, outlet piping should be sized to accommodate pump's flow rate while minimizing pipe friction losses. It should also be designed to prevent gas and air pockets. Piping downstream of pump should include a vent at highest point in system to allow air to escape during priming.

D.8 SHAFT PACKING AND SEAL LEAKAGE

Pump should be installed so any leakage from shaft packing or shaft seal does not become a hazard. Packing leakage should be about 8 to 10 drops per minute. A small amount of liquid may also leak from mechanical or lip seals (usually less than or equal to 10 drops per hour). Provisions should be made to collect leakage from packing or shaft seals.

	WARNING	DANGER
If not appropriately collected, packing leakage may make floor slippery or expose personnel to hazardous fluids.		

D.9 QUENCHED SHAFT SEALS

Some pumps include quenched mechanical shaft seals. For these pumps, a low pressure stream of steam, nitrogen, or clean water is supplied from an external source to atmospheric side of seal faces.

Quenching is used in selected seal applications to:

- Heat or cool seal area.
- Prevent build up of coke formations by excluding oxygen.
- Flush away undesirable material build-up around dynamic seal components.
- When quenched mechanical seals are part of pump assembly, an appropriate quenching stream must be supplied by user.

NOTE: Refer to pump or pump/driver outline drawing and/or specific pump's instruction manual for quench connection size and port locations.

D.10 GAGES

Pressure and temperature gages are recommended for monitoring pump's operating conditions. These gages should be easily readable and placed as close as possible to pump's inlet and outlet flanges. See Figure 10a.

D.11 IDEALIZED INSTALLATION FOR PUMPS LOCATED ABOVE LIQUID LEVEL

Figures 10a and 10b are compilations of Figures 7, 8 and 9 showing good-practice installation schemes for pumps located above the liquid reservoir in systems that recirculate the pumped liquid.

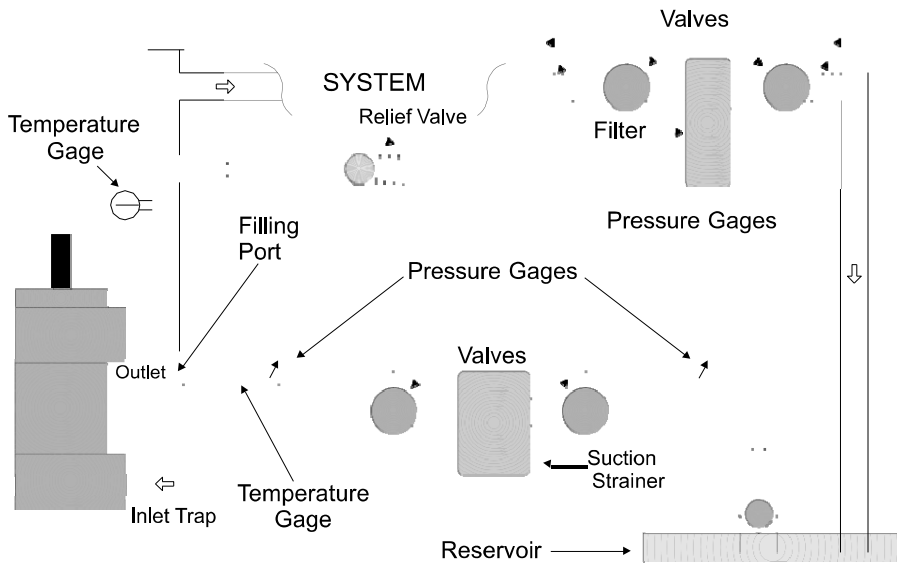

Figure 10a – Vertical Mounted Pump

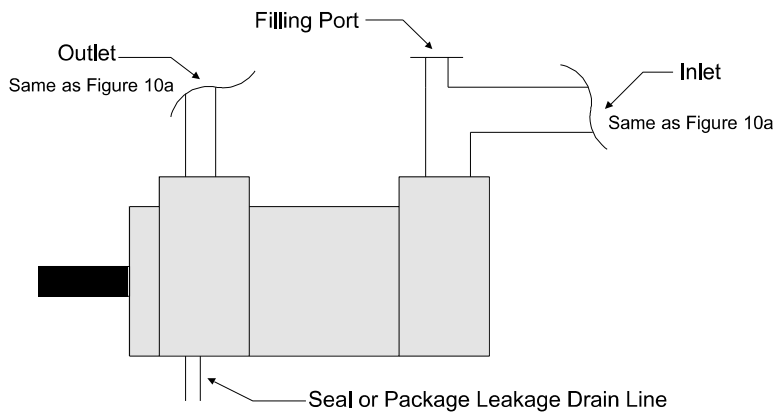

Figure 10b - Horizontal Mounted Pump

E. Startup, Operation and Shutdown

CAUTION	ATTENTION
Operation conditions, such as speed, liquid viscosity, temperature, inlet pressure, discharge pressure, filtration, duty cycle, drive type, mounting, etc., are interrelated. Due to these variable conditions, specific application limits may be different from pump's operating and structural limits. Equipment must not be operated without verifying system's operating requirements are within pump's capabilities.	

	DANGER
Make sure all power equipment is disconnected and locked-out before proceeding.	

E.1 ELECTRICAL CONNECTIONS

Verify electrical requirements for driver match electrical supply with respect to voltage, number of phases and terminal connections. Also, check that driver has been wired to rotate in correct direction.

E.2 ROTATION

Before connecting couplings, check pump rotation to be sure it matches rotation of driver. When coupling is connected and shafts are correctly aligned, pump should turn freely by hand. Rotation direction is indicated by an arrow cast on casing or by an attached plate showing a rotation direction arrow. See Figure 11.

CAUTION	ATTENTION
Operating pump in reverse direction may cause pump damage. Make sure rotation direction is not confused with inlet or outlet flow direction arrows.	

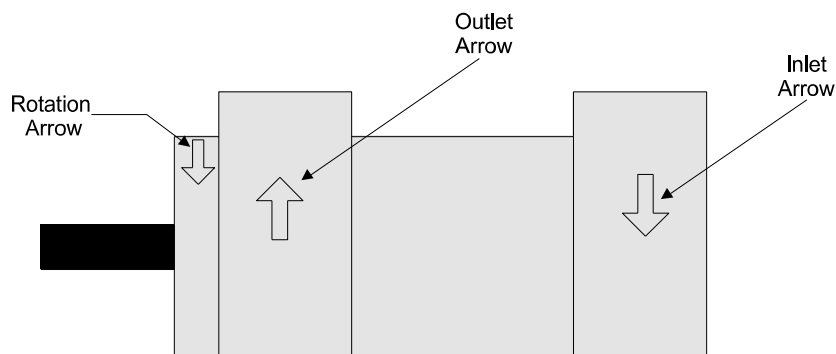

Figure 11 – Rotation Arrow

E.3 HYDROSTATIC TESTING THE SYSTEM

Before any system is hydrostatically tested, pump must be removed or isolated.

CAUTION	ATTENTION
To prevent damage to pump, it is necessary to remove or isolate it from the system prior to starting hydrostatic testing.	

E.4 PROTECTIVE DEVICES

E.4.1 General

Automatic shutdowns, emergency switches, and similar controls should be part of pumping system. They are generally supplied by system supplier or user.

E.4.2 Covers and Guards

Before start-up, insure all protective-covers and guards are in place.

	WARNING	DANGER
<p>To protect personnel from accidental contact with rotating couplings, sheaves, belts, shaft keys, keyways, etc., install the following covers or guards over:</p> <ul style="list-style-type: none">• Bracket openings on flange mounted pumps.• Couplings and shafts on foot mounted pumps.• Sheaves, gears, chains, belts or other type drives.		

E.4.3 Valves

Check all valves, especially those that are manually operated, to be sure they are in proper position. Check that there is no possibility of starting pump with a blocked suction or discharge line.

	WARNING
<p>Starting a pump with discharge line blocked and without adequate relief protection will cause catastrophic pump failure and possible injury to personnel.</p>	

E.5 INTERMEDIATE DRIVE LUBRICATION

Some Imo pump units include intermediate gearboxes or other devices between pump and driver. When these devices are present, lubrication is required. Add lubricant to specified level per device manufacturer's recommendations before start-up.

E.6 HEATING JACKETS

Some pumps require heating before start-up. See Section E.12 on Thermal Shock and Operating Temperature Limits. This is usually done with steam, hot water, heat transfer fluid or electric heat strips. Some pumps are fitted with heating jackets (sometimes called steam jackets). Where electric heating is used, fill jacket with appropriate heat transfer fluid prior to start-up. Unless specified otherwise, maximum permissible pressure in a heating jacket is 150 psi gage.

	WARNING
<p>Provide safeguards to prevent personnel from coming in contact with hot liquid or other heated equipment surfaces.</p>	

E.7 QUENCHED SHAFT SEALS

When quenching fluid is hot water or steam, apply to seal at least 30 minutes prior to pump start-up to insure seal area is thoroughly heated. When steam is used, it should be saturated at about 4 to 7 psi gage. When quench fluid is ambient temperature nitrogen, it can be applied just prior to pump start-up.

E.8 PUMPED LIQUIDS

NEVER operate a pump with water. Pump is designed for liquids having general characteristics of oil. In closed or recirculating systems, check liquid level in tank before and after start-up to be sure it is within operating limits. If initial liquid level is low, or if it drops as system fills during start-up or pumping operations, add sufficient clean liquid to tank to bring liquid to its normal operating level. Only use liquid recommended or approved for use with equipment. Regular checks should be made on condition of liquid. In closed systems, follow supplier's recommendations for maintaining liquid and establishing when liquid is to be changed. Be sure temperature is controlled so liquid can not fall below its minimum allowable viscosity which occurs at its maximum operating temperature. Also, insure that maximum viscosity at cold start-up does not cause pump inlet pressure to fall below its minimum required value.

CAUTION	ATTENTION
<ul style="list-style-type: none">• NEVER operate a pump without liquid in it!• Operate only on liquids approved for use with pump.	

	WARNING
If not appropriately collected, packing or seal leakage may make floor slippery and/or expose personnel to hazardous fluids.	

E.9 PUMP AND SEAL CHAMBER PRIMING

Pump Priming:

Prime pump before initial start-up by pouring some of liquid to be pumped into fill point in system or directly into pump suction port. Rotate pump slowly by hand until rotors or gears (pumping elements) are wet and suction line is as full of liquid as possible. **See Figure 12.**

CAUTION
- Dry-starting a pump is likely to cause damage to pumping elements.

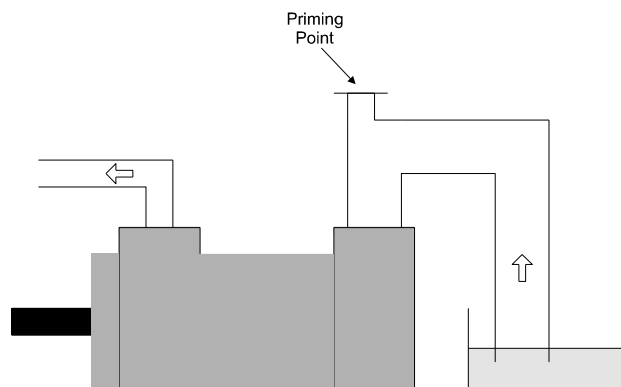

Figure 12 – Priming Pump Using Priming Port

SEAL CHAMBER PRIMING:

Fill mechanical seal chamber with liquid to insure seal does not start dry. This can be done by removing seal vent set-screw and pouring fluid into seal vent before opening pump inlet. Alternately, seal chamber can be vented in situations where inlet pressure is above atmospheric by opening inlet and discharge valves and then loosening seal vent plug to allow positive inlet pressure to push air out of seal chamber until oil flows from it. **See Figure 13.**

Seal chamber priming for 3E model pumps with mechanical seals:

For the Imo 3E Model pumps with mechanical seals, there is no seal vent port. The mechanical seal in these model pumps is located in the discharge chamber of the pump and is in the fluid flow path. In these model pumps the complete pump must be filled and vented of any trapped air prior to starting the pump. Contact the factory if you have questions. **See Figure 8 on page 12 and Figure 12 on page 18 of this manual for suction piping and pump filling methods.**



Figure 13 – Filling or Venting Seal Cavity Using Seal Vent

CAUTION

- Failure to fill or vent seal chamber as described above may cause damage to seal running faces which may result in seal leakage.

E.10 START-UP

It is suggested that driver be started and immediately stopped (jogged) three or four times in order to verify proper pump rotation and to insure pump is filled with liquid. Open bleed port at high point in system and vent trapped air until a solid stream of liquid emerges (where practical). When pump is running, check for unusual noise or vibration. Investigate any abnormalities. Check inlet and outlet gages to see if pump is operating within its ratings. Generally in most pump types, differential pressure across the pump should be a minimum of 40 psi to insure proper pump operation; this pressure may vary based on specific pump types. It is highly recommended that more specific guidance be requested from the factory if this information has not been previously provided.



WARNING

- Precautions must be taken when venting air in system using hazardous liquids.
- Provide hearing protection whenever high noise levels are expected from system components and/or environment.
- If operating temperatures exceed 140° F (60° C), measures should be taken to avoid skin contact.

E.11 SHAFT PACKING (STUFFING BOX) LEAKAGE

Pumps with packing-type seals must be checked to insure packing gland is not too tight. Excessive gland pressure on packing will cause a scored shaft, overheating and rapid breakdown of packing. Keep gland nuts only finger tight. After new packing has been installed, gland nuts should be tightened evenly but only tight enough to seat packing rings properly. Then, loosen gland nuts and re-tighten finger tight. The final adjustment should allow a leakage of approximately ten drops per minute while pump is operating. This leakage is necessary to lubricate the packing. Provide a place for safe draining and disposal of this leakage.

	WARNING
If not appropriately collected, packing leakage may make floor slippery and/or expose personnel to hazardous fluids.	

E.12 THERMAL SHOCK AND OPERATING TEMPERATURE LIMITS



During pump start-up, as well as during pump operation, pump must not see a thermal shock greater than 50° F (28° C) from liquid entering pump. Rapid temperature changes beyond this limit must be avoided. Unless approved by Imo, liquids entering pump inlet must not be hotter than 225° F (107° C) nor colder than 0° F (-18° C). Most pumps also have temperature limits of 225° F to 0° F. Maximum rate of temperature change during pump heating or cooling should be about 1.5° F/minute (0.8° C/minute). A heated or cooled pump should be held at its start-up temperature for at least an hour prior to start-up. This will insure uniform temperature distribution throughout pump assembly.

CAUTION	ATTENTION
Never exceed minimum or maximum allowable pump or liquid temperature. Do not expose equipment to thermal shock. Differences in metallurgy and their respective coefficients of expansion could cause distortion of pump parts resulting in a breakdown condition. Use of insulation and heating jacket or heat tracing to maintain pump at liquid temperature is recommended in high temperature applications.	

E.13 SHUTDOWN

If system is to be shut down for a short period, do not drain pump as this would require re-priming at start-up. If pump is to be stored, apply a rust-inhibiting agent (one compatible with all pump materials) to all internal and external surfaces, especially those that are machined.

F. MAINTENANCE

	DANGER	
BEFORE starting any maintenance procedure, do the following:		
<ul style="list-style-type: none">• Shut off all power switches and circuit breakers.• Remove any electrical service fuses.• Lock electrical service panel supplying power to driver.• Shut, wire or chain, and lock all valves in pump inlet/outlet piping.• If applicable, shut off any steam or other fluid supply lines to pump.		

F.1 FILTERS AND STRAINERS

All filter and strainer elements should be periodically checked for cleanliness and cleaned or replaced as necessary. This will protect equipment from damage due to pressure-drop across clogged or dirty elements.

F.2 FOUNDATION

Foundation and hold-down bolts should be checked for tightness at least every six months.

F.3 ALIGNMENT

Alignment of pump and its driver should be checked and corrected, if necessary, at least every six months. If system experiences an unusual amount of vibrations or large variations in operating temperatures, this should be done often. Well-maintained alignment will help insure maximum equipment life.



WARNING

Rotating parts, such as couplings, pulleys, external fans, or unused shaft extensions should be permanently guarded against accidental contact with personnel or clothing. This is particularly important where parts have surface irregularities such as keys or set- screws.

F.4 LUBRICATION

F.4.1 Bearings

Pump environment, operating conditions and intervals between bearing checks all effect bearing life. Bearings have a finite life and should be checked often for increase in temperature and/or rough operation. If either condition is noted, stop equipment and replace bearing. When grease or oil fittings are provided, lubricate bearings as specified in applicable pump instruction manual.

CAUTION

ATTENTION

Continued running with a rough or worn bearing can lead to catastrophic bearing failure which could cause seal and/or pump failure.

F.5 PACKING

A pump should be repacked when all packing gland travel is exhausted or when packing is damaged. Follow packing replacement instructions in applicable pump instruction manual.

F.6 SHAFT SEALS AND LEAKAGE

Visually check equipment frequently for signs of damage/leakage from shaft seals, gaskets or O-rings. Be sure all connections are tight. If seal leakage is more than about 10 drops per hour per seal, shut down equipment and repair or replace necessary parts. Shaft seals have a finite life which is affected by operating conditions and environment. Expect them to wear and eventually fail. When leakage becomes unacceptable, replace seal unit with one compatible with pump's operating conditions. Dirty liquids will reduce seal life.

NOTE: A very small amount of leakage (~10 drops per hour per seal) is normal, even when shaft seals are new.

NOTE: Make sure any seal leakage is disposed of properly.



WARNING

Since leakage or seal failure can be expected to eventually occur, be sure installation can withstand this situation. Take appropriate measures if liquid is hazardous.

F.7 SPARE PARTS

Where pump out-of-service time is of vital concern, and this down time must be minimized, a set of spare parts or repair kits should be retained on-site.

F.8 DISASSEMBLY AND REASSEMBLY

Various procedures for disassembly and reassembly apply to different pumps. Refer to the specific pump instruction manual on how to perform these procedures.

G. FIELD AND FACTORY SERVICE AND PARTS

Imo Pump maintains a staff of trained service personnel that can provide pump installation, pump start-up, maintenance/overhaul and troubleshooting supervision as well as installation and maintenance training.

Our factories provide maintenance as well as overhaul and test facilities in the event the user prefers to return pumps for inspection or overhaul. Pumps that have been factory-overhauled are normally tested and warranted “as-new” for a period of one year from date of shipment.

For either field service or factory overhaul assistance, contact your local Imo Sales Office or representative at the Technical/Customer Service Department in Monroe, NC, USA.

Most pumps have repair kits available. Minor Repair Kits are used to repair leaking seals, bad bearings and/or for re-assembly after pump tear-down. They include (as applicable) pump shaft seals, packing, all gaskets/O-rings and bearings. Major Repair Kits are sufficient to rebuild completely worn-out pumps to “as-new” condition. They include all parts found in Minor Repair Kits plus all major internal parts subject to wear. Since kits have all the necessary parts, it is preferred that they be purchased rather than selecting individual parts. When parts are individually selected from the Parts List, some needed components are often overlooked. In addition, mixing worn or used parts with new parts risks rapid wear and shortened service life from the new parts.

H. TROUBLESHOOTING

MALFUNCTION	POSSIBLE CAUSE	REMEDY
Loss of Flow or Low Capacity	System component malfunction	Inspect all system components. Correct any malfunctions. Insure that suction and discharge lines are open and all valves are in proper positions.
	Pump not primed or vented	Check reservoir oil level and fill as required. Vent air from pump.
	Low pump speed	Insure driver is not overloaded. For belt drives, insure belt not slipping. For variable speed drivers or variable speed intermediate devices, insure proper speed is set.
	Incorrect pump rotation	Correct direction of driver rotation.
	Obstruction in piping	Inspect all system piping and valves. Remove any obstructions.
	Wear of rotors and/or housings	Replace worn rotors, gears, and/or housing(s).
	System bypass	Check all system bypass valves, including relief valve. Repair or replace as required.
	Insufficient inlet pressure	Remove obstruction. Clean suction strainer or filter element.
Loss of Suction	Suction line closed, blocked or leaking	Verify suction line valve is locked open. Inspect suction line, especially joints. Remove any obstruction and repair any leaks. Clean strainer or replace filter.
	Excessive viscosity	Reduce viscosity by heating pump and/or system liquids.
	Dirty suction strainer	Clean or replace strainer or filter element.
	Wrong direction of rotation	Correct direction of driver rotation.
Low Discharge Pressure	Low liquid level in reservoir	Check liquid level in reservoir. Fill as necessary.
	Air in system	Insure pump is vented and suction lines are full of liquid.
	Worn rotors, gears, and/or housing(s)	Replace worn rotors, gears, and/or housing(s).
	Obstruction in piping	Inspect inlet piping and suction valve(s). Remove any obstruction(s).
	Dirty suction strainer	Clean/replace suction strainer or filter element.
	System bypass problem	Check all system bypass valves for leakage, including relief valves. Repair or replace as required.

H. TROUBLESHOOTING (Continued)

MALFUNCTION	POSSIBLE CAUSE	REMEDY
Excessive or Unusual Noise or Vibration	Misalignment	Check pump and driver alignment and correct as required.
	Restricted suction line	Check suction line and remove any obstructions.
	Air in system	Insure pump is vented and suction lines are full of liquid. Check reservoir level. Fill as necessary. Check all lines, flanges, joints and connections for leakage. Repair as necessary.
	Dirty suction strainer	Clean suction strainer or filter element.
	Relief valve chatter or leakage	Check discharge relief valve pressure setting. Re-adjust, repair or replace relief valve.
	Heavy internal rubbing of pump parts	Verify pump and driver alignment. Inspect pump wearing parts. Replace as required.
	Mechanical problem	Check for loose or mis-positioned coupling, bent or broken shafts, or worn bearing. Repair or replace as required.
Rapid Pump Wear	Fluid contains abrasive foreign matter	Collect samples of liquid and test for foreign matter. Reduce downstream filter ratings in re-circulating systems (do not exceed NPIPR). If necessary, replace liquid in re-circulating systems.
	Fluid contains water	Remove any water from reservoir. Find source and prevent further ingestion.
	Misalignment	Check pump and driver alignment. Correct as required.
	Insufficient liquid	Check liquid level in reservoir and correct as required. Remove any suction line obstructions. Clean/replace strainer or filter element.
Excessive Power Usage	Fluid more viscous than specified	Heat fluid to proper viscosity and/or design temperature.
	Pump suction and/or discharge lines closed or blocked	Insure suction and discharge lines are open, and remove obstructions if present.
	Heavy internal rubbing of pump parts	Verify pump and driver alignment. Inspect pump wearing parts. Replace as required.
	Excessive pump speed	Reduce pump speed to design limits.
	Mechanical problems	Check for bent shaft, tight shaft parking, or pipe strain. Repair or replace as required.

I. UNPACKING INSPECTION RE-PRESERVATION:

UNPACKING, INSPECTIONS & RE-PRESERVATION INSTRUCTIONS FOR PUMP & PUMP MOTOR UNITS

UNPACKING INSTRUCTIONS

Pumps, Pumps with Drivers Units, Large Parts, & Kits shipped on wooden skids.

STEP 1. Remove all wood screws attaching covers or removable tops and vertically lift covers or tops off the skids.

Note: Screw locations are identified on sides of cover or on removable tops.

STEP 2. Remove lag screws & washers, or bolts, nuts & washers, which hold down the equipment.

STEP 3. Remove equipment from skids.

Note: Use of spreader bars is recommended for vertical lifting. Motor lifting lugs may not be capable of supporting entire pump with motor units. Contact factory if in doubt.

STEP 4. Move skids, covers or tops and all hardware to appropriate storage area for reuse.

Pumps & Pumps with Drivers Units mounted and shipped on fabricated metal base plates

Covers may be constructed as complete boxes for removal by vertical lifting or may be constructed in sections with one or more access panels for inspection and re-preservation of the contained equipment clearly marked.

REQUIRED INSPECTIONS & RE-PRESERVATION ACTIONS

Caution

Re-preservation actions may result in spillage of residual oil or preservative from the pump. Be prepared with adequate spill collection and plans for proper disposal.

Note

A maintenance log, kept with these instructions, identifying each completion of required re-preservation actions is strongly recommended.

Frequency: Quarterly {3-Month Intervals}

Required Action: Rotate Motor Shaft

STEP 1. Unpack unit per Steps 1-4 above.

STEP 2. Remove barrier material wrapping from motor & pump shaft extensions and coupling. Residual preservative need not be removed, but may be removed with mineral spirits or naphtha.

STEP 3. Remove fasteners, blanking plates and gaskets from inlet and outlet flanges.

STEP 4. Slowly rotate the motor and pump shafts at least 15 complete turns to assure that greased bearings are fully protected by distribution of fresh lubricant during storage periods.

STEP 5. Apply fresh coat of a P-2 type preservative to the motor & pump shaft extensions and coupling, and re-wrap with barrier material.

STEP 6. Apply fresh coat of a P-2 type preservative to the inlet and outlet flange faces. Re-install gaskets, blanking and fasteners on the pump flanges.

STEP 7. Re-attach the unit to the skid and re-attach the cover using original fasteners.

J. UNPACKING INSPECTION RE-PRESERVATION:

UNPACKING, INSPECTIONS & RE-PRESERVATION INSTRUCTIONS FOR PUMP / MOTOR UNITS (CONTINUED)

Frequency: Semi-Annual {6-Month Intervals}

Required Action: Motors with Re-Greasable Bearings: Add Fresh Grease to Motor Bearings

- STEP 1. Unpack unit per Steps 1-4 above.
- STEP 2. Remove barrier material wrapping from motor & pump shaft extensions and coupling. Residual preservative need not be removed, but may be removed with mineral spirits or naphtha.
- STEP 3. Remove fasteners, blanking plates and gaskets from inlet and outlet flanges.
- STEP 4. Remove all plugs from motor grease fill and drain lines.
- STEP 5. Add fresh grease to motor bearing fill lines in the following approx. amounts:
- | | | | | |
|---------------------------|----------|---------|---------|--------------|
| Motor Frame Size: | Thru 215 | 254-286 | 326-365 | 405 & Larger |
| Grease Volume in cu. in.: | 0.5 | 1.0 | 1.5 | 2.5 |
- STEP 6. Slowly rotate the motor and pump shafts at least 15 complete turns to assure that greased bearings are fully protected by distribution of fresh lubricant during storage periods.
- STEP 7. Reinstall all plugs to motor grease fill and drain lines.
- STEP 8. Apply fresh coat of a P-2 type preservative to the motor & pump shaft extensions and coupling, and re-wrap with barrier material.
- STEP 9. Apply fresh coat of a P-2 type preservative to the inlet and outlet flange faces. Re-install gaskets, blanking and fasteners on the pump flanges.
- STEP 10. Re-attach the unit to the skid and re-attach the cover using original fasteners.

Frequency: Annually {12-Month Intervals}

Required Action: Re-Preserve Pump

- STEP 1. Unpack unit per Steps 1-4 above.
- STEP 2. Remove all barrier material wrapping.
- STEP 3. Remove fasteners, blanking plates and gaskets from pump inlet & outlet.
- STEP 4. Clean, dry and inspect all external surfaces. Mechanically remove any surface rust.
- STEP 5. Connect pump inlet to a P-2 type preservative supply and rotate pump and motor shafts to draw fresh preservative into and throughout pump internals.
- STEP 6. Remove drain plugs, drain excess preservative from pump, and re-install plugs.
- STEP 7. Apply fresh coat of a P-2 type preservative to the inlet and outlet flange faces. Re-install gaskets, blanking and fasteners on the pump flanges.
- STEP 8. Coat external unpainted machined surfaces [shaft extensions, couplings, and bracket mounting surfaces] with a uniform film of a P-2 type preservative and re-wrap with barrier material.
- STEP 9. Re-attach the unit to the skid and re-attach the cover using original fasteners.

UNPACKING, INSPECTION & RE-PRESERVATION INSTRUCTIONS FOR PUMPS, LARGE PARTS & KITS ORDERS

UNPACKING INSTRUCTIONS

- STEP 1. Remove all wood screws attaching the cover or top of box and remove cover or top.
Note: Screw locations are identified on sides of cover or top of box.
- STEP 2. Remove lag screws & washers, or bolts, nuts & washers, which hold down the equipment.
- STEP 3. Vertically lift the equipment free of the box.
- STEP 4. Move container and hardware to appropriate storage area for reuse.

REQUIRED INSPECTIONS & RE-PRESERVATION ACTIONS

PUMPS: Frequency: Annually {12-Month Intervals} **Required Action: Re-Preserve Pump**

Caution

Re-preservation actions may result in spillage of residual oil or preservative from pumps.
Be prepared with adequate spill collection and plans for proper disposal.

- STEP 1. Unpack per Steps 1-4 above.
- STEP 2. Remove all barrier paper wrapping.
- STEP 3. Clean, dry and inspect all external surfaces. Mechanically remove any surface rust.
- STEP 4. Remove fasteners, blanking plates and gaskets from pump inlet & outlet.
- STEP 5. Connect pump inlet to a P-2 type preservative supply and rotate pump shaft to draw preservative into and throughout pump internals.
- STEP 6. Remove drain plugs, drain excess preservative from pump, and re-install plugs.
- STEP 7. Apply fresh coat of a P-2 type preservative to the inlet and outlet flange faces. Re-install gaskets, blanking and fasteners on the pump flanges.
- STEP 8. Coat external unpainted machined surfaces [shaft extension, coupling, bracket mounting surfaces, etc.] with a uniform film of P-2 preservative and re-wrap with vapor barrier wrap.
- STEP 9. Return to original packaging.

Frequency: Annually {12-Month Intervals} **LARGE PARTS & KITS: Required Action: Inspect and Re-Preserve**

- STEP 1. Unpack per Steps 1-4 above.
- STEP 2. Remove all barrier paper wrapping.
- STEP 3. Clean, dry and inspect all external surfaces. Mechanically remove any surface rust.
- STEP 4. Coat Items made from non-corrosion resistant metallic materials such as Steels and Cast Irons; with fresh preservative and re-wrap with vapor barrier wrap.
- STEP 5. Return to original packaging.

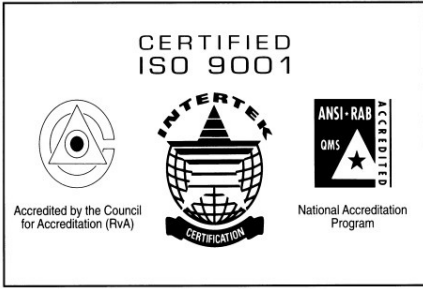

CIRCOR
1710 Airport Road
PO Box 5020
Monroe, NC USA
28111.5020
Tel: +1. 877.853.7867
Email: cc@circor.com
Web: www.circorpt.com

